

Pelekis GSM Gateway 4G Global Coverage for Elevators



Contents

GENERAL WARNINGS	4
DESCRIPTION	5
MAIN FEATURES	6
THE GSM GATEWAY	7
INSTALLATION	8
Tips for the Installation	8
Mount	9
SIM Card	10
Antenna	11
Connecting the Autodialer	12
Power Supply 230VAC	13
Battery	14
Starting the GSM Gateway	14
Normal Operation	15
PROGRAMMING BY SMS	16
PROGRAMMING BY App	19
NORMAL OPERATION	25
Incoming Call Handling	26
Outgoing Call Handling	26

Contents

LED Signaling	27
Record Voice Messages	29
RECORD PROCEDURE	30
Warranty and Technical Support	32
Our Lift Phones EN81-28:2022	33

GENERAL WARNINGS

GENERAL REMARKS

Please pay close attention to the warnings in this section, as they provide important guidelines for safe installation, proper use, and maintenance of the product.

The appliance must be used exclusively for its intended purpose. Pelekis Electronics cannot be held responsible for any damage resulting from improper use.

The product has been designed in compliance with relevant standards. Installation must be carried out in accordance with these standards and within compliant installations.

Before performing any interventions (cleaning, maintenance, connection, etc.), disconnect the appliance from the main power supply and the battery.

For any repair work, please contact our after-sales service, in Pelekis Electronics or your Local Distributor, exclusively.

Ensure that the product is installed according to the prescribed instructions.

Do not introduce objects, liquids, or dust into the product, and do not use sprays inside the product.

To achieve better 4G GSM network reception, install the gateway as high as possible within the building, ideally in high machinery areas or at the top of the elevator shaft.



Electrical equipment must be compulsorily recycled according to Directive n°2012/19/EU relating to waste electrical equipment and Electronic (WEEE).

DESCRIPTION

The Pelekis 4G GSM Gateway connects to emergency phone devices in elevators, allowing them to make and receive calls via the mobile network. A SIM card is required for this operation. (It can operate also SIMless, calling IEN 112).

- Pelekis 4G GSM Gateway features an internal backup battery and a charger.
- Pelekis 4G GSM Gateway provides a reliable power supply for the emergency phone in the elevator, whether the main AC power is live or during a power outage.

When combined with the Pelekis Emergency Autodialer for Car Lifts (INTD0901, INTD0902), the system ensures robust and reliable two-way communication between trapped passengers and service personnel.

Pelekis GSM Gateway
4G VoLTE



ANTENNA
(wire 2m)



BATTERY
SLA 12V 900mAh

MAIN FEATURES

- Remote Programming via SMS
- Remote Programming via Application for Android and iOS
- Remote Firmware Update (changing SD Card)
- Checking the battery's health and notify with SMS
- Remote Reset
- Mobile network signal intensity (LED indication)
- 4G signal Enabled (LED indication)
- Battery status (LED indication)
- Power status (LED indication)
- Global 4G Coverage Module for all over the world
- Up to 2 prerecorded messages stored for trapped and rescue personnel
- Automatic PSTN and GSM Selection.
- Micro SIM Card
- SIM-less operation by calling IEN 112
- Backup communication 6 Hours in case of power outage.
- Power supply 230VAC
- Output power supply for Autodialers 12VDC
- Battery 12V 900mAh



Download the Application “Pelekis GSM Configurator” from App Store (iOS) or PlayStore (Android).

THE GSM GATEWAY

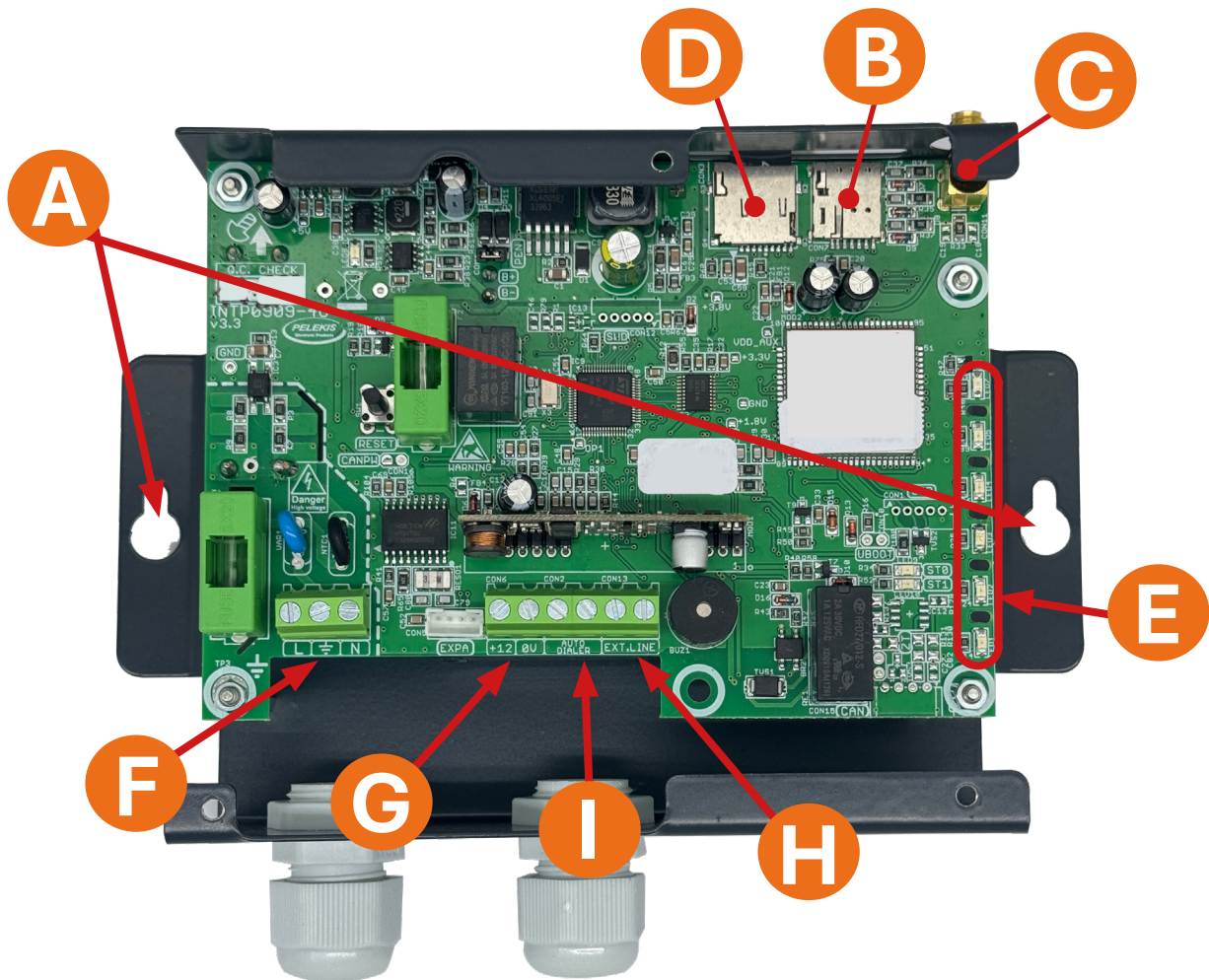

- A** Mount Holes
- B** SIM Card Slot
- C** Antenna SMA Connector
- D** SD Card Slot
- E** LED Indications (see chapter “Signals” on page 27)
- F** GSM’s power supply. Connect 230VAC.
- G** Output power supply 12VDC. Power Supply to Autodialer.
- H** Connect PSTN if available.
- I** Telephone connection to Autodialer.

INSTALLATION

Tips for the Installation

- The Pelekis GSM Gateway 4G must be installed as high as possible within the building, ideally in high machinery areas or at the top of the elevator shaft.
- Avoid installing the GSM Gateway above the Car Lift, while the move can affect the signal negatively.
- Make all connection before supplying AC power to the Pelekis GSM Gateway to avoid any electric shock or short circuits.
- The GSM Gateway should be installed indoor because is not protected against water, which could provoke damage.
- Before the actual installation on site, the device should be connected on the desk as simulation.

**Power Consumption is 3.5W in Peak Condition
with all features enabled and all LEDs ON.**

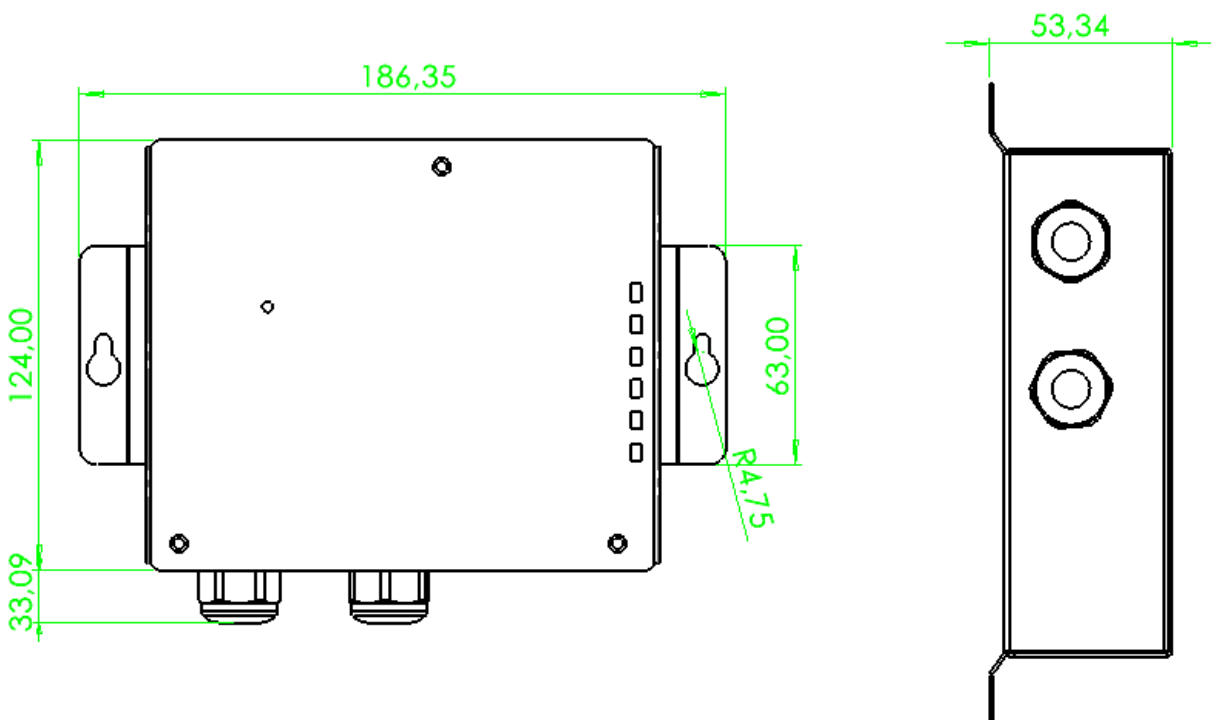

INSTALLATION

1

MOUNT

Place the Pelekis GSM Gateway 4G at the top of elevator shaft.

Locate an area where the GSM signal is sufficient.

Pelekis Electronics recommends at the top of the shaft or in the Machine room if the Signal is strong.

Note: The network may vary depending on the telephone Provider.

- Drill two holes of 5mm in diameter on the wall, after you have marked with the device.
- Insert 2 dowels in the holes and tighten 2 screws, 1 on each dowel.
- Place the Pelekis GSM Gateway 4G device, through the holes, on the screws.

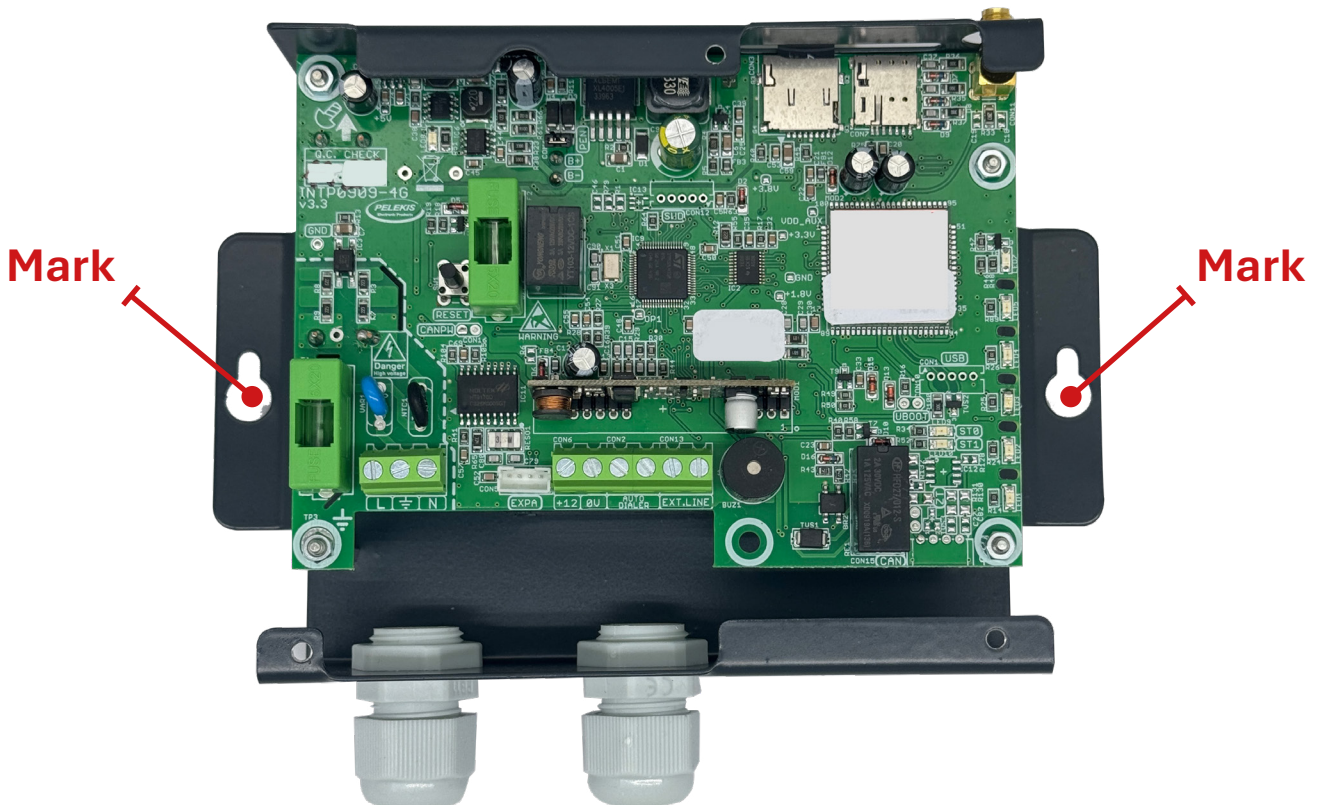

INSTALLATION

2

SIM Card

Before inserting the SIM card, make sure that the device is switched off to avoid any damage.

Use all precautions to avoid electrostatic discharge.



ATTENTION

**The SIM card must have the PIN CODE DEACTIVATED.
If the SIM Card has the PIN CODE activated, it must be de-activated using a cell phone.**



ATTENTION

Make sure your SIM Provider has enabled the VoLTE capability on your SIM Card

Slide the SIM Card from outside the metal enclosure to the SIM card Slot, with the correct orientation and side.

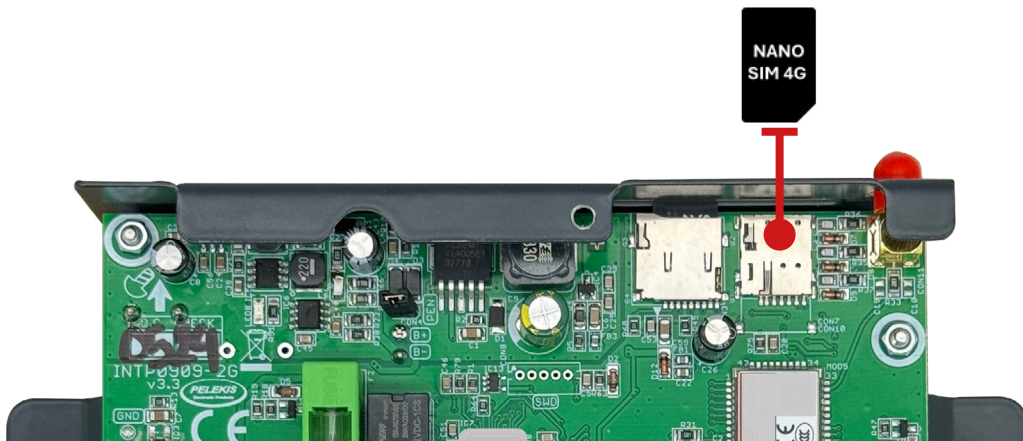

INSTALLATION

3 ANTENNA



WARNING

Before connecting the Antenna, make sure that the device is switched OFF to avoid any damage.

Screw the Antenna, which will be found in the package, into the SMA connector on the Pelekis GSM Gateway 4G.

To ensure a strong Signal, place the antenna out of any metal box or structures that may affect the Signal receiving.



**Tighten
Good**

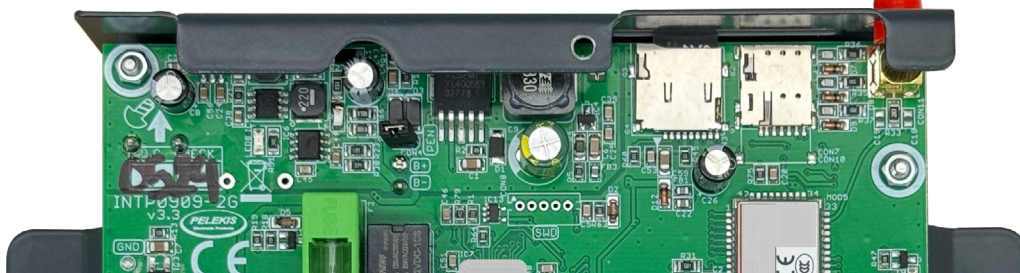

INSTALLATION

4

Connecting the Autodialer

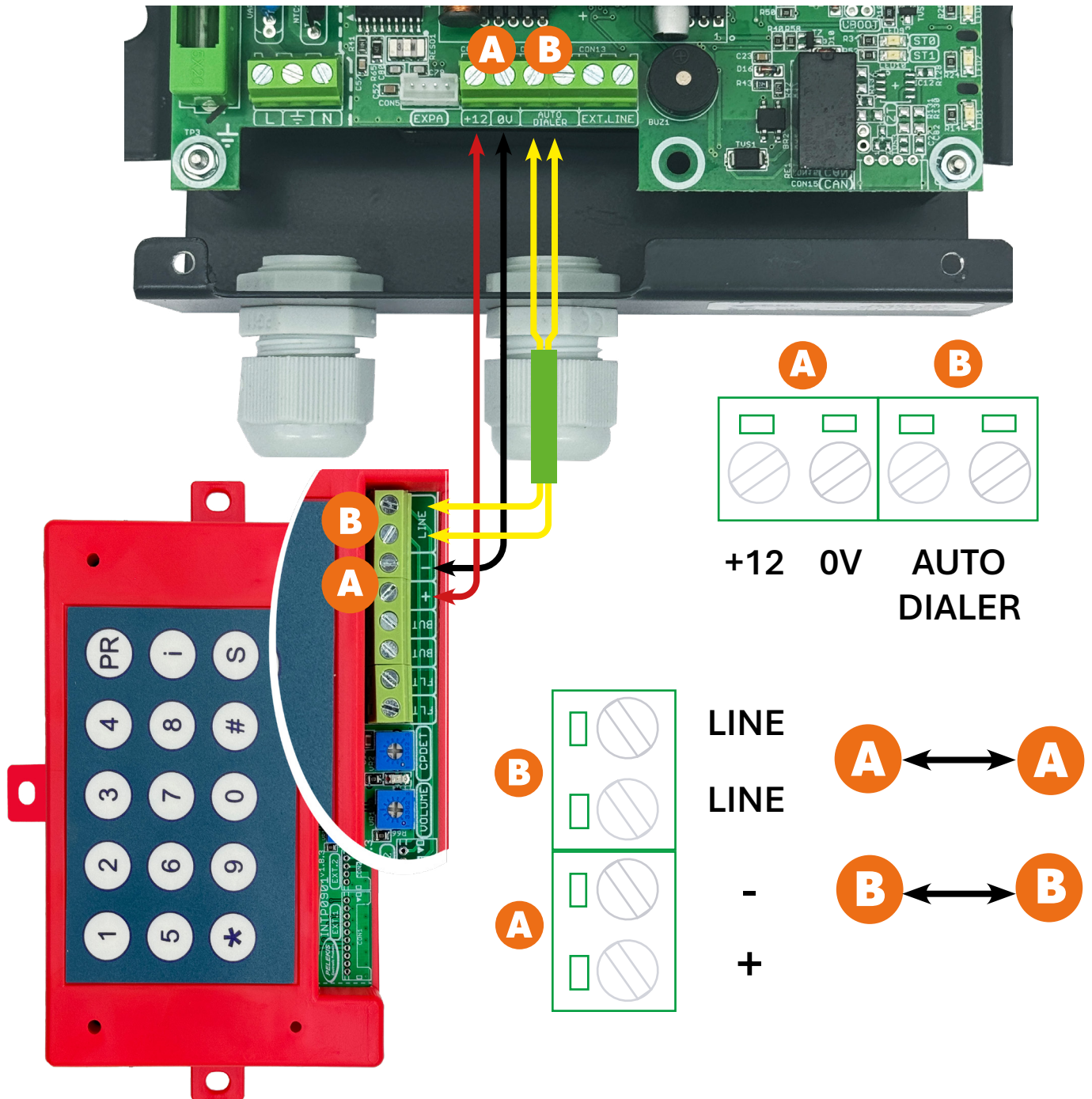

INSTALLATION

5

Power Supply 230VAC

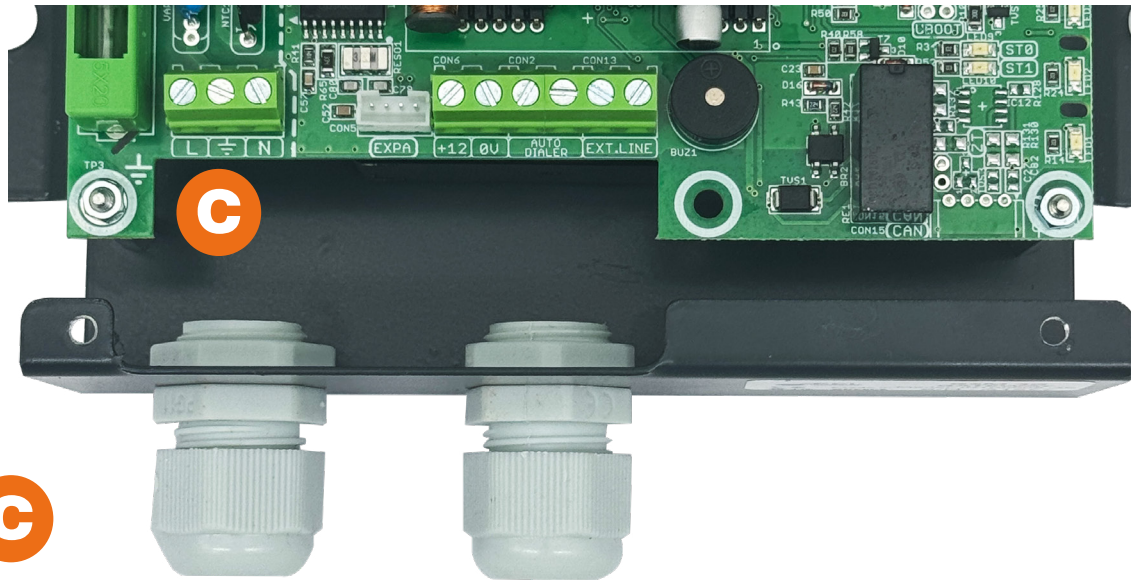

C

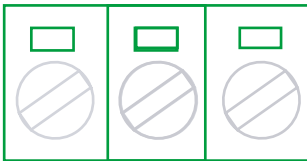

L E N



ATTENTION

Complete all the previous steps before connecting power supply.

Connect the external Power Supply 230VAC to the terminal L/E/N of the Pelekis GSM Gateway 4G.

INSTALLATION

6

Battery



ATTENTION

The battery is pre-connected by default, and no additional setup is required.

- Close the cover of the Pelekis GSM Gateway paying attention to the wires.

7

Starting the GSM Gateway

- Power up the Pelekis GSM Gateway 4G.
Make Sure the Main Power ON LED is enabled.
- Wait at least 30 seconds to 5 minutes until the proper registration of the device to 2G, 3G or 4G mobile network.
- Check in page 27, “LED Signaling” to recognise when device is ready to operate normally.

8

Normal Operation

Upon completion of startup and initialization, the device enters Normal Operation mode.

In this mode, the operation of the GSM Gateway is transparent, allowing any dialed number from a connected telephone or autodialer to be initiated normally.



Note!

The programming step is not required for the normal operation of the Pelekis GSM Gateway 4G.



Note!

The following programming steps should be performed if special functionalities are required by the user. (See page 16-18)

PROGRAMMING BY SMS

Programming via SMS can be performed from any mobile phone.



ATTENTION 1

The SMS Programming method requires credit on the SIM Card of GSM Gateway!



ATTENTION 2

All the SMS start with #0000#.
This is the factory parameter password.
This password can be changed. (see CODE 3)



ATTENTION 3

After any valid SMS is received by the GSM Gateway, the system will reply with an "OK" message in case of parameter edit or with the requested information after an "ask" message.

PROGRAMMING BY SMS



CODE	Description	Program	Ask (Returns what has been programmed)
USER AUTHORIZED PROGRAM CODES			
1	Programming 4 Calling Numbers (1)	#0000#1#X1,X2,X3,X4* Xn=phone number Don't forget comma (,) between phone numbers	#0000#1#?
2	Call Number in case of Low Battery	#0000#2#X1* Xn=phone number	#0000#2#?
3	Edit password	#0000#3#XXXX*	XXXX can be only numbers
4	Incoming Call Functionality	#0000#4#0* (Disable) #0000#4#1* (Enable)	#0000#4#?
5	IEN 112 Functionality	#0000#5#0* (Disable) #0000#5#1* (Enable)	#0000#5#?
6	Device Information	Returns Firmware Version and IMEI Number	#0000#6#?
7	Control Output Relays	#0000#7#R1=0* (Relay OFF) #0000#7#R1=1* (Relay ON)	#0000#7#?
8	Control Input Optocouplers	#0000#8#0* (AUTO OFF) #0000#8#1* (AUTO ON)	#0000#8#?
9	Force GSM Call Function (2)	#0000#9#0* (Disable) #0000#9#1* (Enable)	#0000#9#?

PROGRAMMING BY SMS

CODE	Description	Program	Ask (Returns what has been programmed)
USER AUTHORIZED PROGRAM CODES			
10	Parameter Factory Reset	#0000#10#1*	
11	Restart Device	#0000#11#1*	
20	Help	Returns ALL the codes which can be used in parameter programming	#0000#20#1?

Note (1) : Programming 4 Calling Numbers 

Up to 4 Emergency Calling Numbers saved in the internal memory of the GSM Gateway (see Note (2)).

Note (2) : Force GSM Call Function 

If enabled, the GSM Gateway will automatically ignore any dialed numbers coming from the connected autodialer. Instead, it will call the four(4) stored numbers from the internal memory of the GSM Gateway until someone answers the call.

PROGRAMMING BY App

Programming via SMS can be performed from any smart phone either Apple or Android.

Download from App Store or Play Store the “Pelekis GSM Gateway Configurator”



ATTENTION

Accept all permission that application requires to work properly!

With the Application we can easily program and configure the required parameters of the Pelekis GSM Gateway 4G.

Available Configuration via App:

- Programming 4 Calling Numbers
- Programming Call Number in case of Low Battery (Service Number)
- Control Remotely Output Relays
- Take Remotely information from Input Optocouplers

PROGRAMMING BY App

Open the application on your mobile, after downloading the App “Pelekis GSM Gateway Configurator”.

This is the Home Screen.

Place the Telephone Number of the SIM Card that has been placed inside the GSM Gateway 4G.

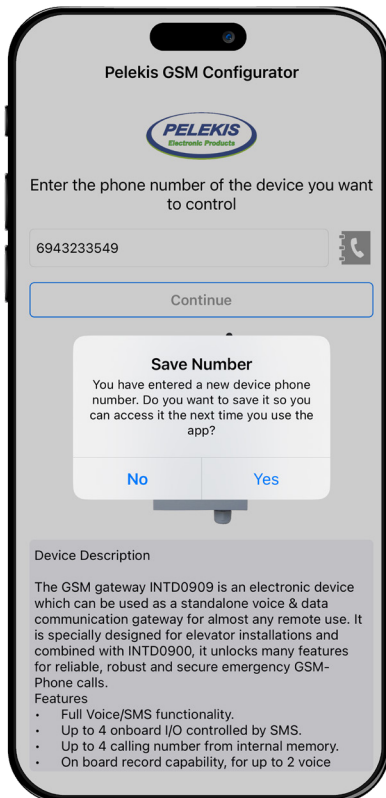
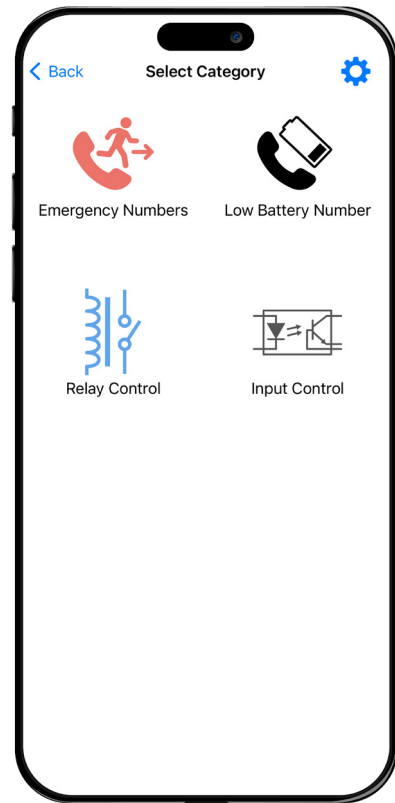

Press Continue and Save the Number.

In this screen appeared the functions you can use.

1) You can store the Emergency Numbers

2) You can store the Low Battery Nymber. When the GSM Gateway has Low Battery, notifies the Low Battery Number for the issue with an SMS.

3) You can control Remotely the Output Relays.

4) You can get notified by the status of the Input Signals.

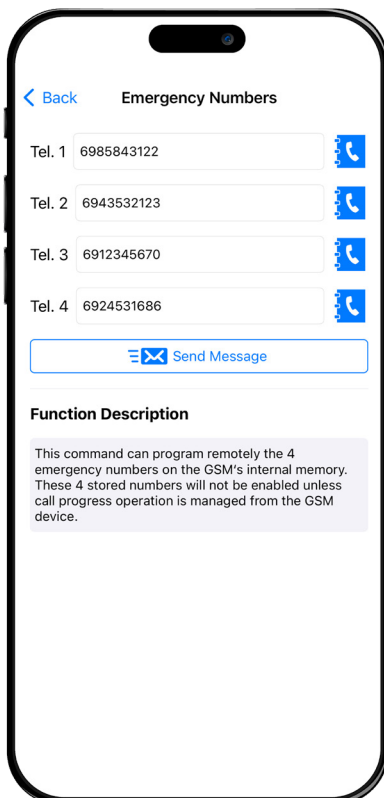
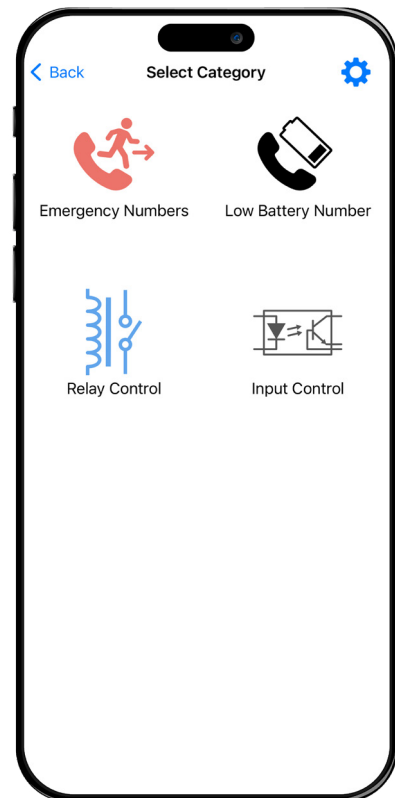

Press the Icon Emergency Numbers.

Save the 4 Emergency Numbers that will be used in case of emergency.

After Completing this Step, press Send Message.

By pressing this Button, an SMS is sent to the GSM to store the 4 Emergency Numbers.

The application opens SMS Messaging App to send the message as it shown on the image to the right.

Press Send.

The numbers have been stored in the internal memory of GSM Gateway.

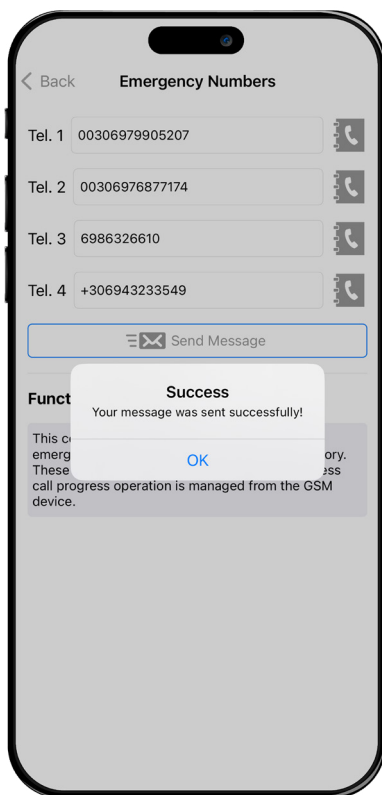
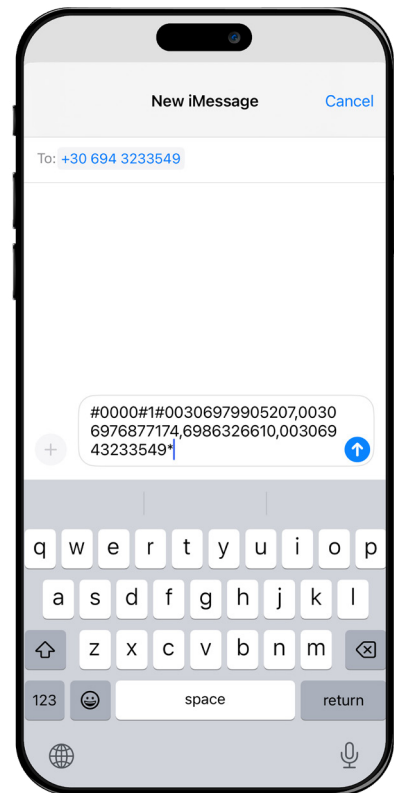

A pop up window notifies you that the procedure was successful.

Define the Service Number for Low Battery Notification.

This notification will arrive as an SMS to the provided Service telephone number.

Press Send Message to be stored in the Pelakis GSM Gateway 4G.

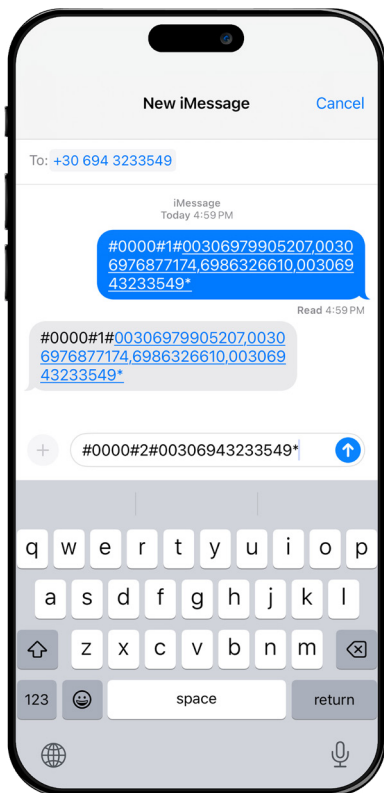
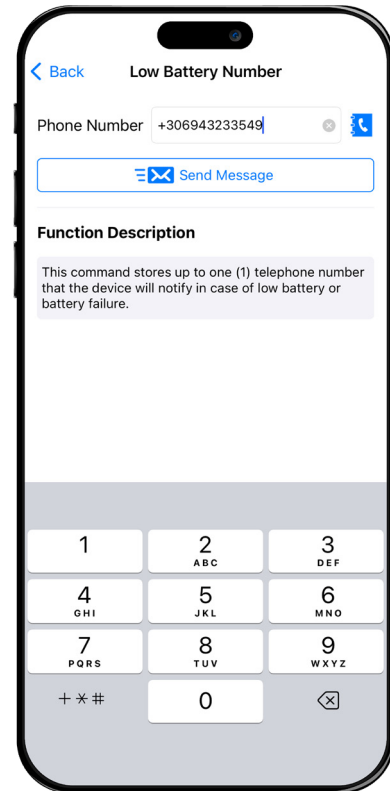

The application opens SMS Messaging App to send the message as it shown on the image to the left.

Press Send.

The number have been stored in the internal memory of GSM Gateway.

A pop up window notifies you that the procedure was successful.

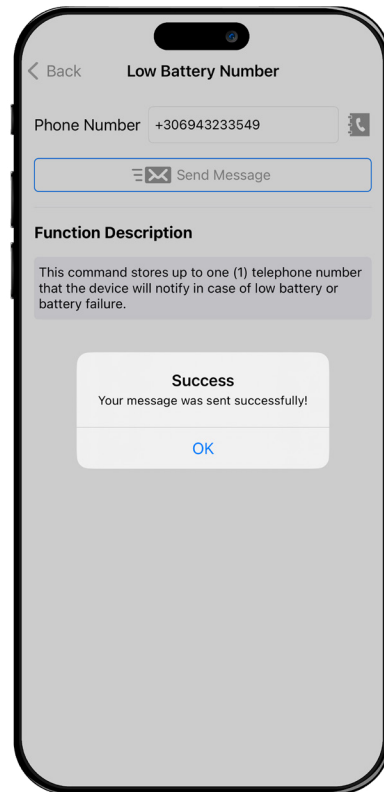

The following images show the remotely operations of Outputs and Inputs.

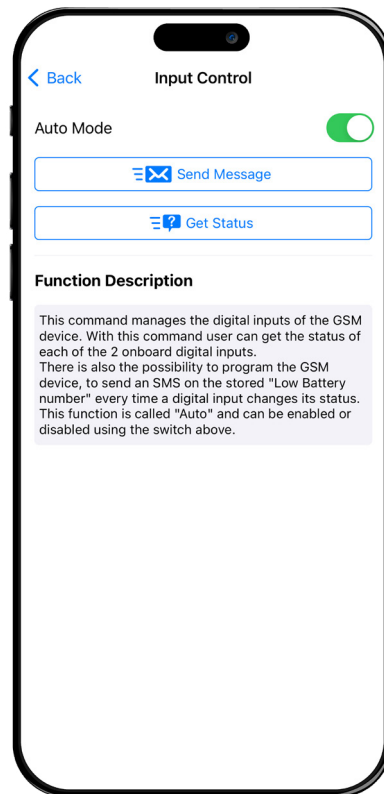
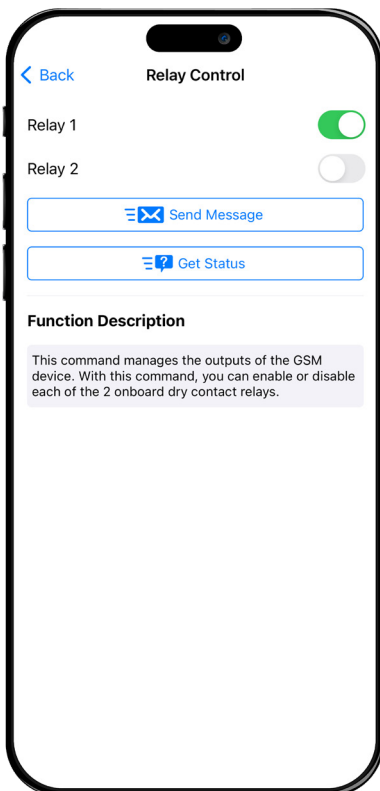

NORMAL OPERATION

Upon the completion of startup and initialization, the device enters the Normal Operation mode.

In Normal Operation mode, the device continuously performs certain actions and executes additional actions triggered by internal or external events.

Continuous Actions:

- Battery Status Check: Monitored in real-time.
- Battery Health Check: Conducted daily one time.
- Network Signal Status: Monitored in real-time.
- SIM Card Presence Verification: Checked every 5 seconds.

Triggered One-Shot Actions:

- Incoming Call Handling
- Incoming SMS Handling
- Emergency Outgoing Call
- Emergency Outgoing SMS Sending
 - “LOW BATTERY WARNING” SMS
 - “LOW BATTERY - DEVICE IS SHUTTING DOWN” SMS
 - BATTERY DESTROYED - PLEASE REPLACE BATTERY” SMS

Incoming Call Handling

When an incoming call is received, the Pelekis GSM Gateway 4G will provide ringing tones to the connected autodialer. If the connected autodialer answers the call, the GSM Gateway will connect the incoming call to the autodialer.

If the incoming call stops, the GSM Gateway will stop generating the ringing tones.

Outgoing Call Handling

The GSM gateway initiates a call for every dialed number provided from the autodialer connection.

- If program setting parameter 9 from the “Programming by SMS” section is enabled, the Pelekis GSM Gateway 4G will select a number from its internal memory (see page 18 Note (2)).
- If program setting parameter 9 from the “Programming by SMS” section is disabled, the Pelekis GSM Gateway 4G will attempt to call the dialed number from the autodialer or the connected telephone device.
- If the dialed numbers cannot be connected, the Pelekis GSM Gateway 4G will initiate an emergency call to the International Emergency Number (IEN) 112.

Note: Enable Program setting parameter 5 from the “Programming by SMS” section to call IEN 112.

LED Signaling

Network Enabled LED	
100ms/100ms	Offline - Trying to reconnect
OFF	NO Service
ON	4G Registered
500ms/500ms	2G or other Service registered

4G LED ON / 2G LED OFF	
if 4G VoLTE	
ON	Searching Network
200ms/200ms	Registered
OFF	The device is powered OFF
if 2G or Other Service	
ON	Searching Network
200ms/200ms	Registered
200ms/800ms	Registered
OFF	The device is powered OFF

Signal Strength LED

OFF	NO Signal
ON	Excellent Signal
500ms/500ms	Good Singal
150ms/150ms	Bad Signal

Battery Status LED

ON	$\geq 13V$ / Flow Charge
500ms/1000ms	$\geq 12V$ / more than 90%
500ms/2500ms	$\geq 11V$ / more than 50%
150ms/3150ms	$\geq 10,5V$ / more than 10%
OFF	$< 10,5V$ / Destroyed, Unable to be Charged

Autodialer Status LED

OFF	LINE IS OFF
Continues ON	HOOK OFF
500ms/500ms	LINE CONNECTED
Other	Receiving or Transmitting Call

Record Voice Messages for Trapped and Service Personnel

This function allows users to store up to two voice messages in the internal memory of the GSM Gateway. According to European standards, GSM gateways should be capable of announcing up to two voice messages for both trapped passengers in the cabin and the rescue service personnel.

Both recorded messages are played during an emergency call.

Voice Message 1: This message is played immediately after the emergency button is activated. Its primary purpose is to help the trapped person remain calm while also informing them that an emergency call to the rescue service is being initiated.

Voice Message 2: This message is played once the connection with the rescue service is established. It provides the rescue service with the location and general information about the incoming emergency call.

Follow the steps to Record your Voice Messages!



RECORD PROCEDURE

Programming the playback of voice messages can be done through any conventional telephone device connected to the Line terminal or just call the number of the GSM Gateway 4G and follow the instructions.

To program using a conventional telephone device:

1. Hook off the earpiece to engage the line.
2. Start the key sequence according to the record process.

To choose the “voice message” to record, press the appropriate key combination:

- To record “Voice Message for Trapped Person” press, ***15***
- To record “Voice Message for Service Personnel” press ***16***

If the code is accepted, the device will emit a short sound (500ms) after 1 second.

Press Key	Function
1	Press to Start and Press to Stop Recording
2	Listen the Recorded Message
*	Enable Message Playback and Exit procedure
#	Disable Message Playback and Exit procedure

RECORD PROCEDURE

Start / Stop Recording:

1. Pressing **Key 1** will cause the device to emit one short sound, indicating that recording has started. The device will continue recording until the maximum record time is reached (15sec).
2. To manually stop the recording, press **Key 1 AGAIN**.
3. After either manually stopping or reaching the maximum record timeout, the device will emit two short sounds, indicating the current recorded message has been saved.

Play Recorded Message:

1. Pressing **Key 2** will cause the device to emit one short sound, and the playback of the recorded message will start immediately.
2. During playback, it is not possible to interrupt the process. Wait until playback is finished to take any further actions.

Enable Message Playback:

1. Pressing **Key *** will cause the device to emit two short sounds.
2. This action enables the current “Voice Message,” even if it is an empty message. The device will then exit the record function and return the GSM Gateway to normal operation.

Disable Message Playback:

1. Pressing **Key #** will cause the device to emit two short sounds.
2. This action disables the current “Voice Message,” even if it is an empty message. The device will then exit the record function and return the GSM Gateway to normal operation.

Warranty and Technical Support

The Pelekis GSM Gateway 4G comes with a comprehensive 5-year warranty, ensuring peace of mind and reliable performance.

We are committed to providing lifetime technical support for our customers. For assistance, you can contact your local distributor or reach out directly to Pelekis Electronics.

For technical support or any inquiries, please contact us at:

Pelekis Electronics

Email: info@pelekis.eu

Phone: +30 210 23 23 345

Website: www.pelekis.tech

We are dedicated to helping you with any questions or issues you may have regarding your Pelekis GSM Gateway 4G.

Thank you for choosing Pelekis Electronics.



Our Emergency Phone Systems for Lifts EN81-28

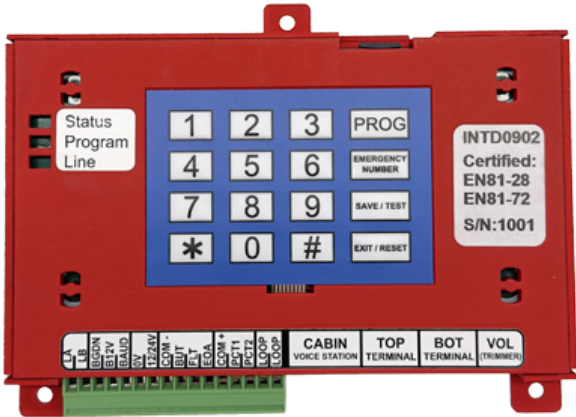

Autodialer for Car Lift EN81-28

Pre-wiring for Bot-Top Communication



Bot-Top Communication Terminal



Intercommunication Terminal



Firecom Floor Terminal

Our Emergency Phone Systems for Lifts EN81-28



Intercommunication System from Machine Room to Car Lift

Autodialer for Car Lift Direct Installation in GEN2 OTIS COP

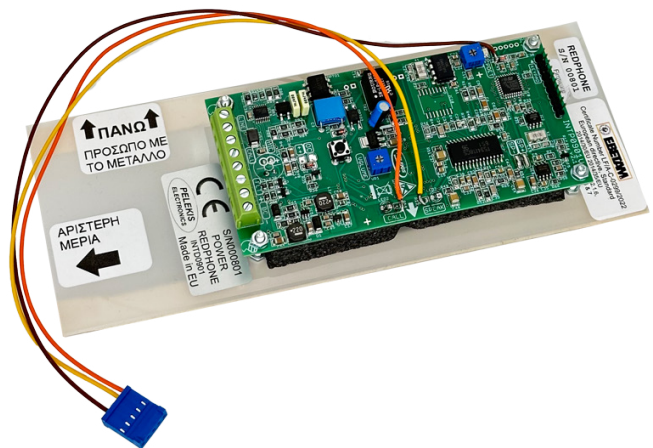

Visit our website at www.pelekis.tech to explore our full range of products or contact us directly via email at info@pelekis.tech .

Space for your notes

Dotted lines for notes.

Pelekis GSM Gateway 4G Global Coverage for Elevators

The most reliable way of Communication for Lifts.

Key Features:

- PSU and Battery Charger included
- Power Supply for Autodialers
- Seamless integration with existing systems
- Remote operation capabilities

Warranty and Support:

- **5-year warranty**
- **Lifetime technical support**

For more information about our product range, visit www.pelekis.tech

Thank you for choosing Pelekis Electronics.

